

# PI85 with socket GZMB80

## interface relays with spring terminals

### RM85 + GZMB80



- Interface relay **PI85 with socket GZMB80** consists of: electromagnetic relay **RM85**, black plug-in socket **GZMB80**, signalling / protecting module **type M...**, retainer / retractor clip **GZMB80-0040** (plastic), white description plate **TR**
- 35 mm rail mount acc. to EN 60715
- Recognitions, certifications, directives: recognitions RM85, RoHS,



### Contact data

Number and type of contacts		1 CO
Contact material		<b>AgNi</b> , AgNi/Au hard gold plating, AgSnO <sub>2</sub>
Rated / max. switching voltage	AC	250 V / 300 V
Min. switching voltage		5 V AgNi, 5 V AgNi/Au hard gold plating, 10 V AgSnO <sub>2</sub>
Rated load (capacity)	AC1	10 A / 250 V AC; 16 A / 250 V AC ①
	AC15	3 A / 120 V 1,5 A / 240 V (B300)
	DC1	16 A / 24 V DC (see Fig. 3)
	DC13	0,22 A / 120 V 0,1 A / 250 V (R300)
Motor load	acc. to UL 508	1/2 HP 240 V AC, 4,9 FLA, single-phase motor ②
	AC3 acc. to IEC 60947-4-1	0,5 kW 240 V AC, single-phase motor
Min. switching current		5 mA AgNi, 2 mA AgNi/Au hard gold plating, 10 mA AgSnO <sub>2</sub>
Max. inrush current		30 A AgSnO <sub>2</sub>
Rated current		16 A
Max. breaking capacity	AC1	4 000 VA
Min. breaking capacity		0,3 W AgNi, 0,05 W AgNi/Au hard gold plating, 1 W AgSnO <sub>2</sub>
Contact resistance		≤ 100 mΩ
Max. operating frequency		600 cycles/hour
• at rated load	AC1	72 000 cycles/hour
• no load		
<b>Coil data</b>		
Rated voltage	50/60 Hz AC	12, <b>24</b> , 110, 120, <b>230 V</b>
	DC	<b>12, 24</b> , 110 V
Must release voltage		AC: ≥ 0,15 U <sub>n</sub> DC: ≥ 0,1 U <sub>n</sub>
Operating range of supply voltage		see Tables 1, 2 and Fig. 4, 5
Rated power consumption	AC	0,75 VA
	DC	0,4 ... 0,48 W
<b>Insulation according to EN 60664-1</b>		
Insulation rated voltage		300 V AC
Rated surge voltage		4 000 V 1,2 / 50 μs
Overtoltage category		III
Insulation pollution degree		3
Dielectric strength		4 000 V AC
• between coil and contacts		1 000 V AC type of clearance: micro-disconnection
• contact clearance		
Contact - coil distance		≥ 10 mm
• clearance		≥ 10 mm
• creepage		
<b>General data</b>		
Operating / release time (typical values)		7 ms / 3 ms
Electrical life		> 0,7 x 10 <sup>5</sup> 16 A, 250 V AC
• resistive AC1		see Fig. 2
• cosφ		
• DC L/R=40 ms		> 10 <sup>5</sup> 0,12 A, 220 V DC
Mechanical life (cycles)		> 3 x 10 <sup>7</sup>
Dimensions (L x W x H)		97 x 16 x 69 mm
Weight		60 g
Ambient temperature	• storage	-40...+85 °C
(non-condensation and/or icing)	• operating	AC: -40...+70 °C DC: -40...+85 °C
Cover protection category		IP 20 EN 60529
Environmental protection		RM85: RTII GZMB80: RT0 EN 61810-7
Shock resistance		30 g
Vibration resistance		10 g 10...150 Hz

The data in bold type relate to the standard versions of the relays. ① Loads above 10 A require bridging pairs of spring terminals: 11 with 21, 12 with 22, 14 with 24 - see page 2. ② For single phase motors for 110-120 V AC do not use motors with higher FLA than given for 240 V AC.

# PI85 with socket GZMB80

## interface relays with spring terminals

### Dimensions

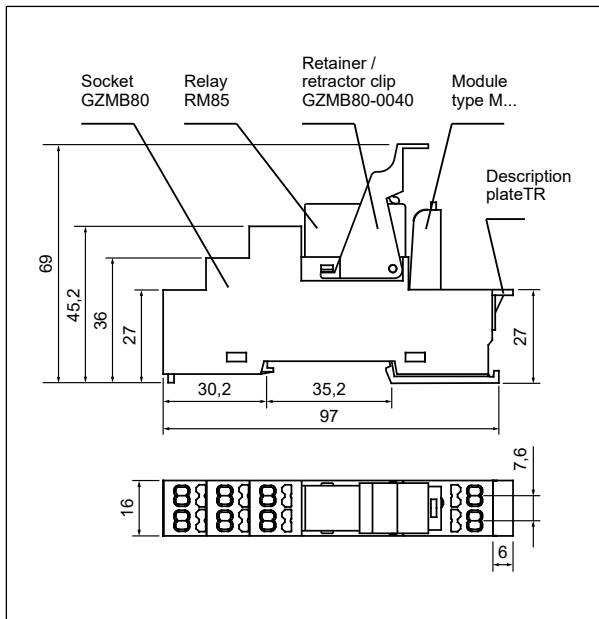

### Mounting

Relays **PI85 with socket GZMB80** are designed for direct mounting on 35 mm rail mount acc. to EN 60715.  
**Connections:** max. cross section of the cables: 1 x 0,2... 1,5 mm<sup>2</sup> (1 x 24...16 AWG), stripping length: 9...11 mm.

### Connection diagrams (spring terminals side view)

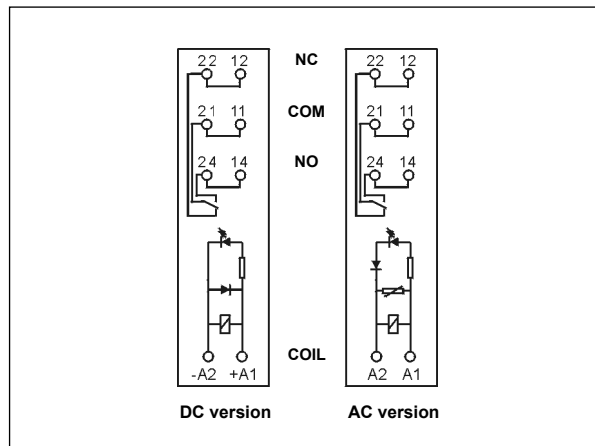

### Connection of GZMB80 socket

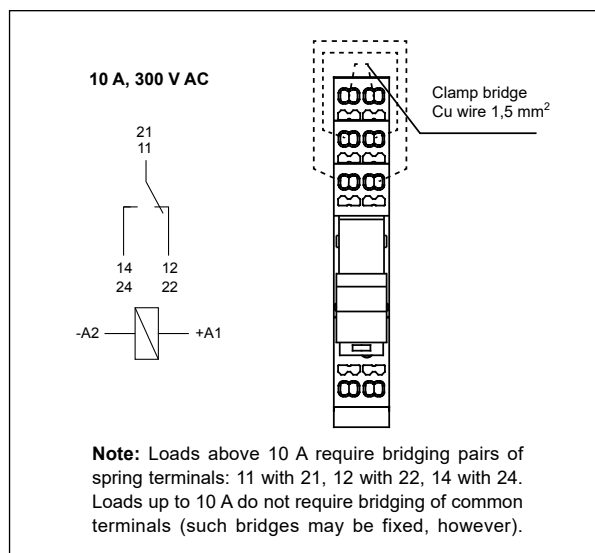

### Wire connection

The drawings present the sequence of operations in course of inserting wires to the spring terminal, and the recommended screwdriver to be used for opening of case springs, comply with the DIN 5264 FORM "A".

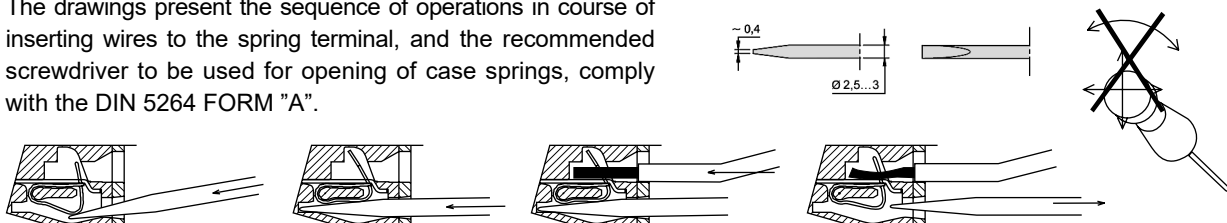

### PRECAUTIONS:

1. Ensure that the parameters of the product described in its specification provide a safety margin for the appropriate operation of the device or system and never use the product in circumstances which exceed the parameters of the product. 2. Never touch any live parts of the device. 3. Ensure that the product has been connected correctly. An incorrect connection may cause malfunction, excessive heating or risk of fire. 4. In case of any risk of any serious material loss or death or injuries of humans or animals, the devices or systems shall be designed so to equip them with double safety system to guarantee their reliable operation.

**Electrical life at AC resistive load.**  
Switching frequency: 600 cycles/hour

Fig. 1

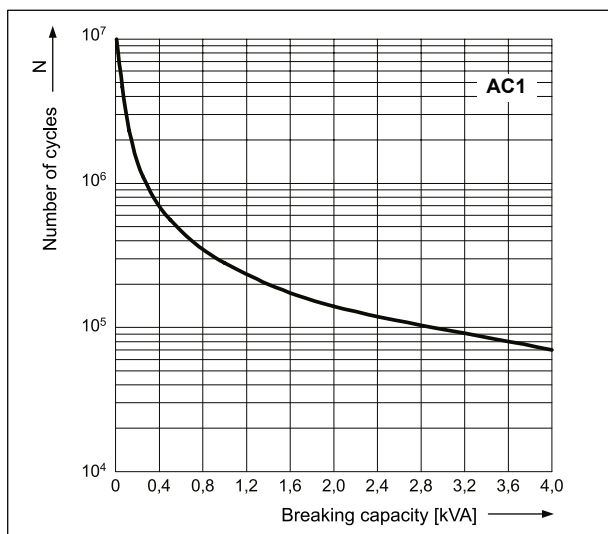

**Electrical life reduction factor at AC inductive load**

Fig. 2

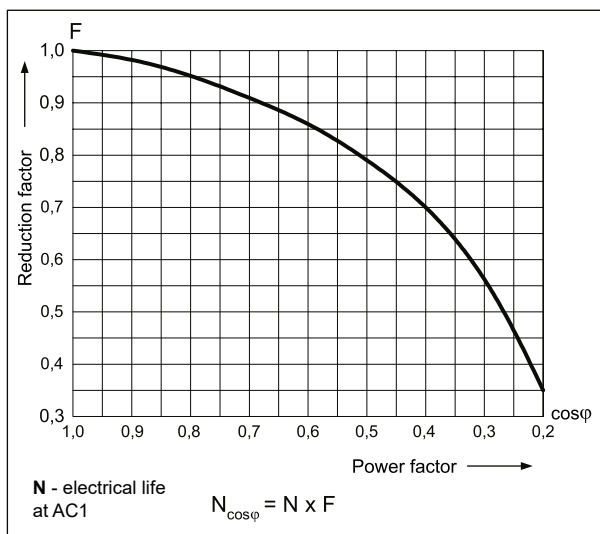

**Max. DC resistive load breaking capacity**

Fig. 3

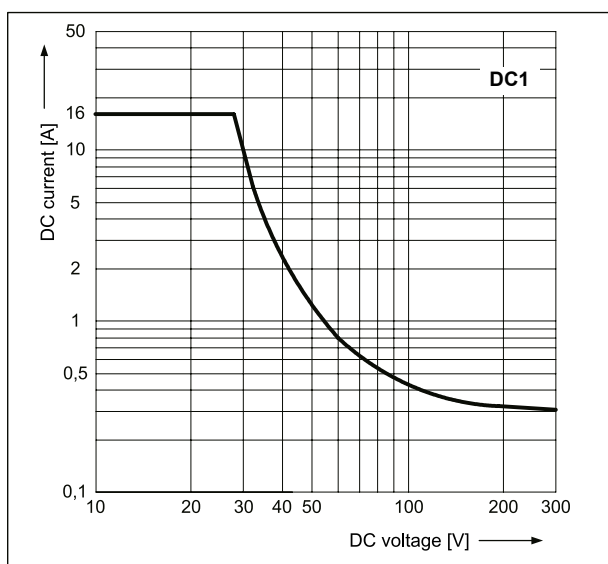

**Coil operating range - DC**

Fig. 4

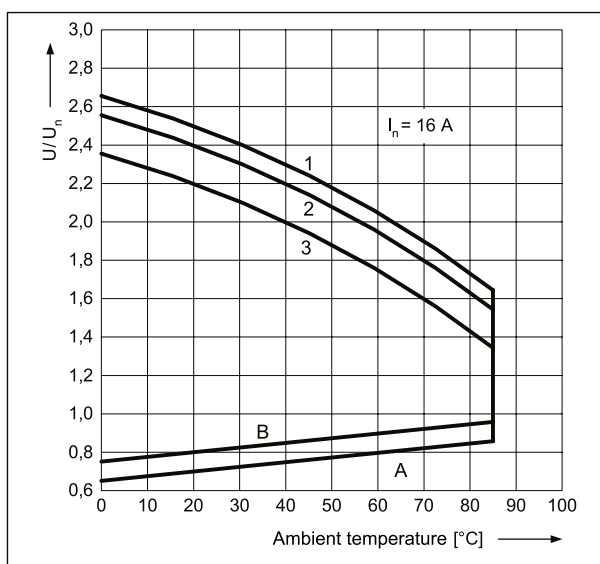

**Coil operating range - AC 50 Hz**

Fig. 5

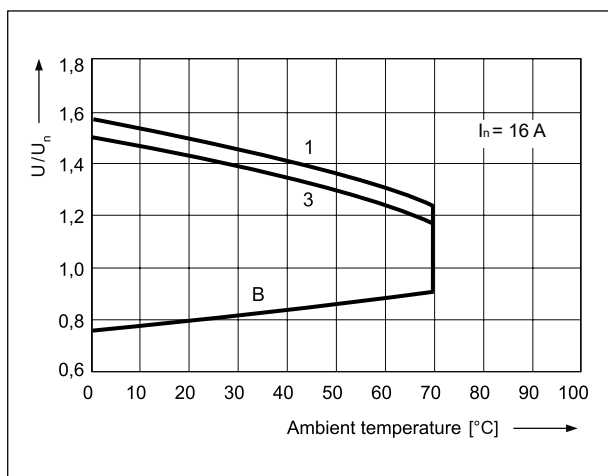

**Description of Fig. 4 and 5**

**A** - relations between make voltage and ambient temperature at no load on contacts. Coil temperature and ambient temperature are equal before coil energizing. Make voltage is not higher than the value read on Y axis (multiplication of rated voltage).

**B** - relations between make voltage and ambient temperature after initial coil heating up with  $1,1 U_n$ , at continues load of  $I_n$  on contacts. Make voltage is not higher than the value read on Y axis (multiplication of rated voltage).

**1, 2, 3** - values on Y axis represent allowed overvoltage on coil at certain ambient temperature and contact load:

- 1** - no load
- 2** - 50% of rated load
- 3** - rated load

# PI85 with socket GZMB80

## interface relays with spring terminals

**Coil data - DC voltage version**

Table 1

Coil code	Rated voltage V DC	Coil resistance at 20 °C Ω	Acceptable resistance	Coil operating range V DC	
				min. (at 20 °C)	max. (at 20 °C)
<b>012DC</b>	<b>12</b>	<b>360</b>	<b>± 10%</b>	<b>8,4</b>	<b>30,6</b>
<b>024DC</b>	<b>24</b>	<b>1 440</b>	<b>± 10%</b>	<b>16,8</b>	<b>61,2</b>
110DC	110	25 200	± 10%	77,0	280,0

The data in bold type relate to the standard versions of the relays.

**Coil data - AC 50/60 Hz voltage version**

Table 2

Coil code	Rated voltage V AC	Coil resistance at 20 °C Ω	Acceptable resistance	Coil operating range V AC 50 Hz	
				min. (at 20 °C)	max. (at 20 °C)
012AC	12	100	± 10%	9,6	13,2
<b>024AC</b>	<b>24</b>	<b>400</b>	<b>± 10%</b>	<b>19,2</b>	<b>28,8</b>
110AC	110	8 900	± 10%	88,0	132,0
120AC	120	10 200	± 10%	96,0	144,0
<b>230AC</b>	<b>230</b>	<b>38 500</b>	<b>± 10%</b>	<b>184,0</b>	<b>276,0</b>

The data in bold type relate to the standard versions of the relays.

### Ordering codes

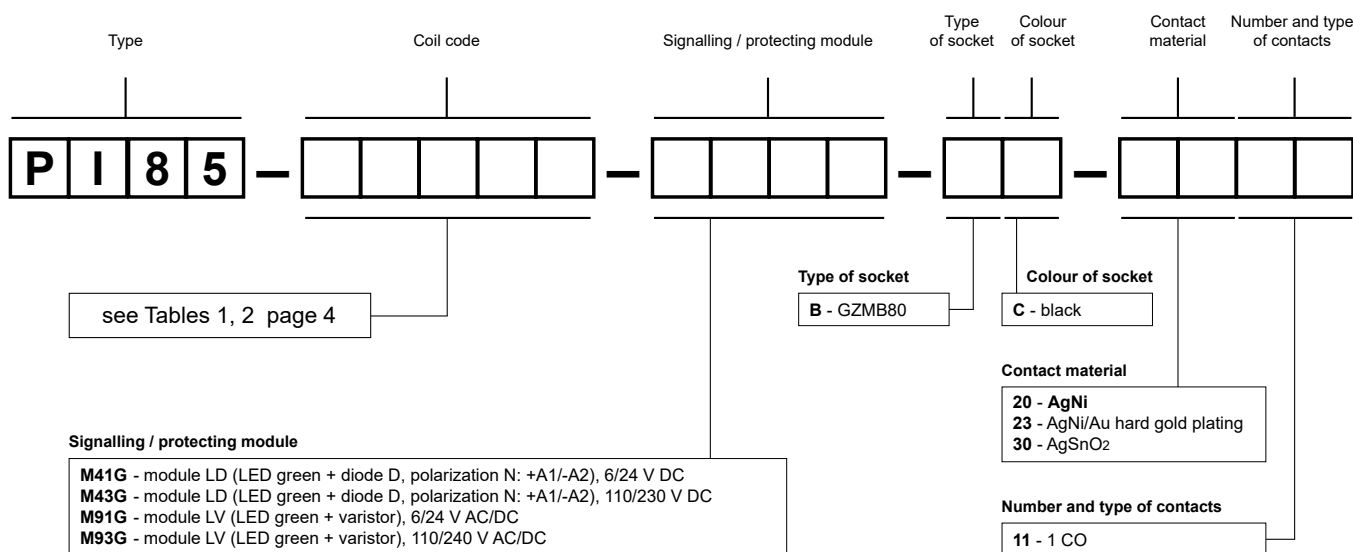

Examples of ordering codes:

**PI85-012DC-M41G-BC-2011**

interface relay **PI85** consists of: relay **RM85** (one changeover contact, contact material AgNi, coil voltage 12 V DC), socket **GZMB80** (black, spring terminals), signalling / protecting module **M41G** (version LD), retainer / retractor clip **GZMB80-0040** (plastic), description plate **TR** (white)

**PI85-230AC-M93G-BC-3011**

interface relay **PI85** consists of: relay **RM85** (one changeover contact, contact material AgSnO<sub>2</sub>, coil voltage 230 V AC 50/60 Hz), socket **GZMB80** (black, spring terminals), signalling / protecting module **M93G** (version LV), retainer / retractor clip **GZMB80-0040** (plastic), description plate **TR** (white)