

# PIR2 with socket GZM2 interface relays

R2N (AC) + GZM2



R2N (DC) + GZM2



- Interface relay **PIR2 with socket GZM2** consists of: electromagnetic relay **R2N**, grey plug-in socket **GZM2**, signalling / protecting module type **M...**, retainer / retractor clip **GZT4-0040** (plastic), white description plate **GZT4-0035**
- 35 mm rail mount acc. to EN 60715 or on panel mounting with two M3 screws • May be linked with interconnection strip type **ZGGZ4**
- Recognitions, certifications, directives: recognitions R2N, RoHS,



## Contact data

|                                |                                  |   |
|--------------------------------|----------------------------------|---|
| Number and type of contacts    |                                  | 2 CO  |
| Contact material               |                                  | <b>AgNi</b>   |
| Rated / max. switching voltage | AC                               | 250 V / 300 V   |
| Min. switching voltage         |                                  | 5 V   |
| Rated load (capacity)          | AC1                              | 12 A / 250 V AC   |
|                                | AC15                             | 3 A / 120 V                      1,5 A / 240 V (B300)               |
|                                | DC1                              | 12 A / 24 V DC (see Fig. 3)   |
|                                | DC13                             | 0,22 A / 120 V                      0,1 A / 250 V (R300)            |
| Motor load                     | acc. to UL 508                   | 1/2 HP                      240 V AC, 4,9 FLA, single-phase motor ❶ |
|                                | AC3 acc. to IEC 60947-4-1        | 0,37 kW                      240 V AC, single-phase motor           |
| Min. switching current         |                                  | 5 mA  |
| Max. inrush current            |                                  | 24 A  |
| Rated current                  |                                  | 12 A  |
| Max. breaking capacity         | AC1                              | 3 000 VA  |
| Min. breaking capacity         |                                  | 0,3 W   |
| Contact resistance             |                                  | ≤ 100 mΩ  |
| Max. operating frequency       | • at rated load AC1<br>• no load | 1 200 cycles/hour<br>18 000 cycles/hour                             |

## Coil data

|                                   |             |   |
|-----------------------------------|-------------|---|
| Rated voltage                     | 50/60 Hz AC | 12, <b>24</b> , 48, 120, <b>230 V</b>             |
|                                   | DC          | 12, <b>24</b> , 48, 110 V                         |
| Must release voltage              |             | AC: ≥ 0,2 U <sub>n</sub> DC: ≥ 0,1 U <sub>n</sub> |
| Operating range of supply voltage |             | see Tables 1,2 and Fig. 4, 5                      |
| Rated power consumption           | AC          | 50 Hz: 1,6 VA                      60 Hz: 1,3 VA  |
|                                   | DC          | 0,9 W   |

## Insulation according to EN 60664-1

|                             |   |  |
|-----------------------------|---|--|
| Insulation rated voltage    |   | 300 V AC   |
| Rated surge voltage         |   | 4 000 V    1,2 / 50 μs   |
| Overvoltage category        |   | III  |
| Insulation pollution degree |   | 3  |
| Dielectric strength         | • between coil and contacts<br>• contact clearance<br>• pole - pole | 2 500 V AC                      type of insulation: basic<br>1 500 V AC                      type of clearance: micro-disconnection<br>2 500 V AC                      type of insulation: basic |
| Contact - coil distance     | • clearance<br>• creepage   | ≥ 2,5 mm<br>≥ 4 mm   |

## General data

|   |  |   |
|---|--|---|
| Operating / release time (typical values) |  | AC: 10 ms / 8 ms                      DC: 13 ms / 3 ms                  |
| Electrical life                           | • resistive AC1<br>• cosφ                    | > 10 <sup>5</sup> 12 A, 250 V AC<br>see Fig. 2                          |
| Mechanical life (cycles)                  |  | > 2 x 10 <sup>7</sup>   |
| Dimensions (L x W x H)                    |  | 75 x 27 x 82 mm   |
| Weight                                    |  | 97 g  |
| Ambient temperature                       | • storage<br>(non-condensation and/or icing) | -40...+85 °C  |
|   | • operating                                  | AC: -40...+55 °C                      DC: -40...+70 °C                  |
| Cover protection category                 |  | IP 20                      EN 60529                                     |
| Environmental protection                  |  | R2N: RTI                      GZM2: RT0                      EN 61810-7 |
| Shock resistance                          | (NO/NC)                                      | 10 g / 5 g  |
| Vibration resistance                      |  | 5 g 10...150 Hz   |

The data in bold type relate to the standard versions of the relays.

❶ For single phase motors for 110-120 V AC do not use motors with higher FLA than given for 240 V AC.

# PIR2 with socket GZM2 interface relays

## Dimensions

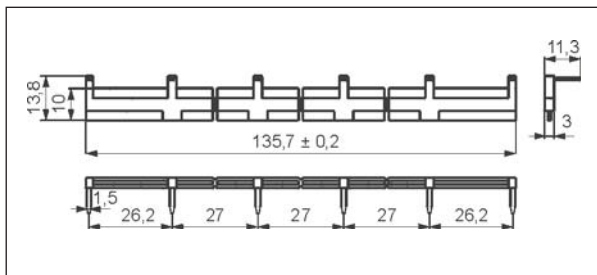
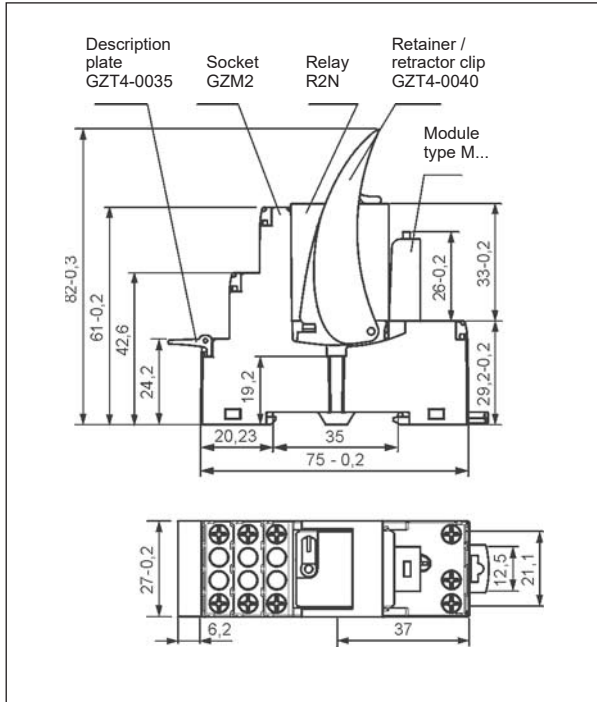

Interconnection strip type ZGGZ4

## Connection diagrams (screw terminals side view)

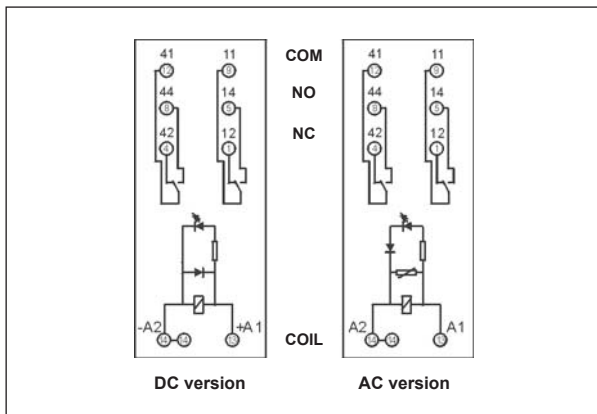

## Mounting

Relays **PIR2 with socket GZM2** are designed for direct mounting on 35 mm rail mount acc. to EN 60715 or on panel mounting with two M3 screws. **Connections:** max. cross section of the cables (stranded): 2 x 2,5 mm<sup>2</sup> (2 x 14 AWG), stripping length: 6,5 mm, max. tightening moment for the terminal: 0,7 Nm.

Plug-in sockets **GZM2** may be linked with interconnection strip type **ZGGZ4**. Strip **ZGGZ4** bridges common input signals, maximum permissible current is 10 A / 250 V AC, possibility of connection of 6 sockets. Colours of strips: **ZGGZ4-1** grey, **ZGGZ4-2** black (see page 5).

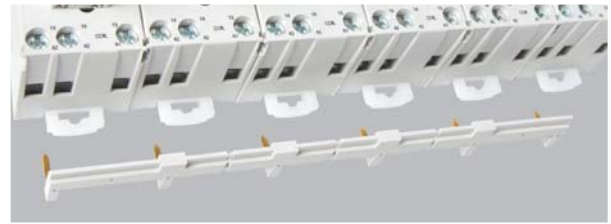

Interconnection strip ZGGZ4: bridging of common input signals.



ZGGZ4

## Electrical life at AC resistive load. Switching frequency: 1 200 cycles/hour

Fig. 1

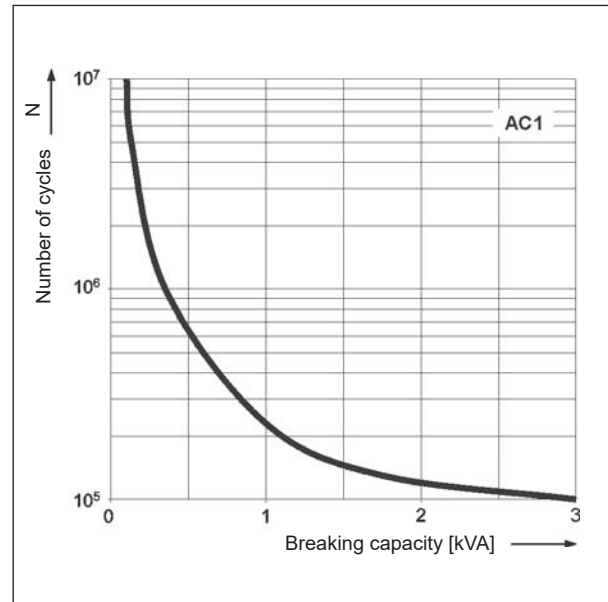

**Electrical life reduction factor at AC inductive load**

Fig. 2

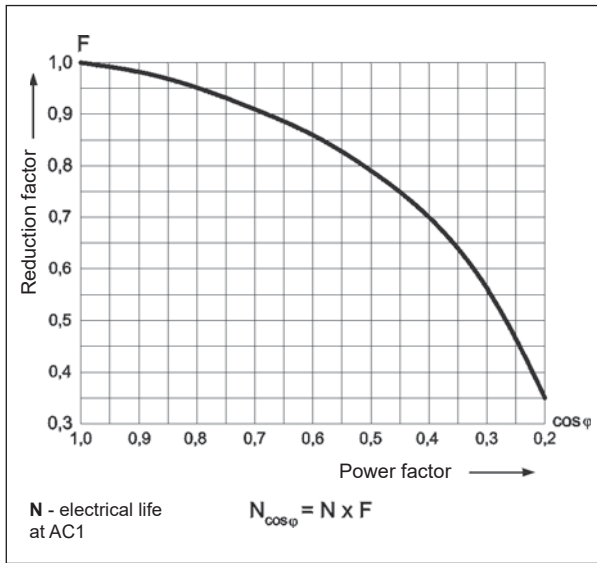

**Max. DC resistive load breaking capacity**

Fig. 3

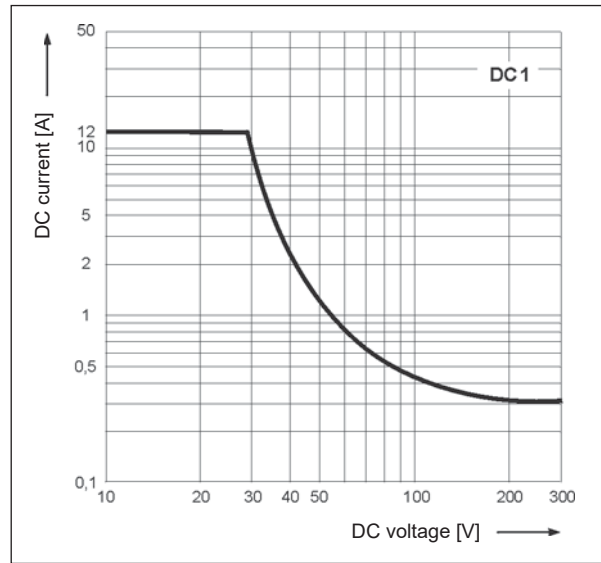

**Coil operating range - DC**

Fig. 4

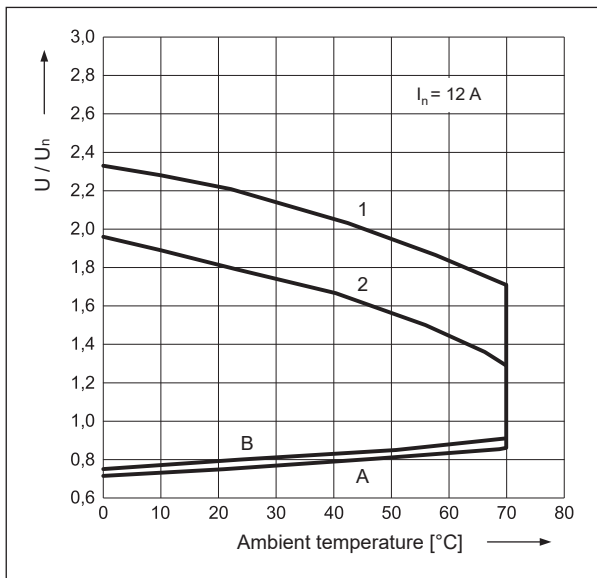

**Coil operating range - AC 50 Hz**

Fig. 5

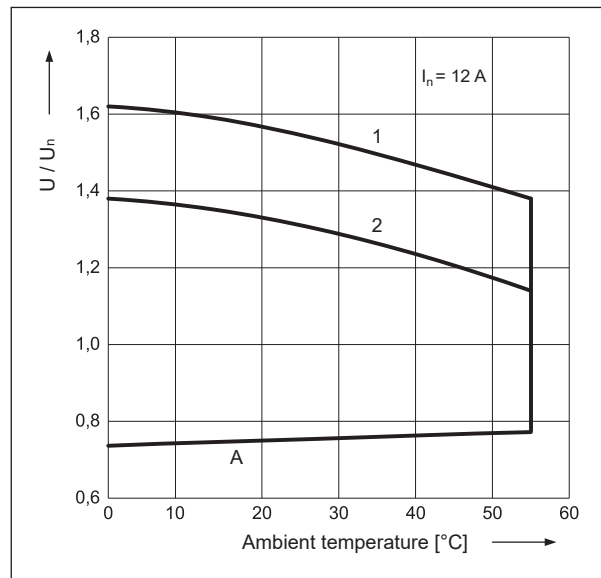

**Description of Fig. 4 and 5**

**A** - relations between make voltage and ambient temperature at no load on contacts. Coil temperature and ambient temperature are equal before coil energizing. Make voltage is not higher than the value read on Y axis (multiplication of rated voltage).

**B** - relations between make voltage and ambient temperature after initial coil heating up with  $1,1 U_n$  at continues load of  $I_n$  on contacts. Make voltage is not higher than the value read on Y axis (multiplication of rated voltage).

**1, 2** - values on Y axis represent allowed overvoltage on coil at certain ambient temperature and contact load:

- 1** - no load
- 2** - rated load

# PIR2 with socket GZM2 interface relays

**Coil data - DC voltage version**

Table 1

| Coil code    | Rated voltage<br>V DC | Coil resistance<br>at 20 °C<br>Ω | Acceptable<br>resistance | Coil operating range<br>V DC |                 |
|--------------|-----------------------|----------------------------------|--------------------------|------------------------------|-----------------|
|              |                       |                                  |                          | min. (at 20 °C)              | max. (at 70 °C) |
| 012DC        | 12                    | 160                              | ± 10%                    | 9,6                          | 13,2            |
| <b>024DC</b> | <b>24</b>             | <b>640</b>                       | <b>± 10%</b>             | <b>19,2</b>                  | <b>26,4</b>     |
| 048DC        | 48                    | 2 600                            | ± 10%                    | 38,4                         | 52,8            |
| 110DC        | 110                   | 13 600                           | ± 10%                    | 88,0                         | 121,0           |

The data in bold type relate to the standard versions of the relays.

**Coil data - AC 50/60 Hz voltage version**

Table 2

| Coil code    | Rated voltage<br>V AC | Coil resistance<br>at 20 °C<br>Ω | Acceptable<br>resistance | Coil operating range<br>V AC |                 |
|--------------|-----------------------|----------------------------------|--------------------------|------------------------------|-----------------|
|              |                       |                                  |                          | min. (at 20 °C)              | max. (at 55 °C) |
| 012AC        | 12                    | 39,5                             | ± 10%                    | 9,6                          | 13,2            |
| <b>024AC</b> | <b>24</b>             | <b>158</b>                       | <b>± 10%</b>             | <b>19,2</b>                  | <b>26,4</b>     |
| 048AC        | 48                    | 640                              | ± 10%                    | 38,4                         | 52,8            |
| 120AC        | 120                   | 3 770                            | ± 10%                    | 96,0                         | 132,0           |
| <b>230AC</b> | <b>230</b>            | <b>16 100</b>                    | <b>± 10%</b>             | <b>184,0</b>                 | <b>253,0</b>    |

The data in bold type relate to the standard versions of the relays.

## Ordering codes

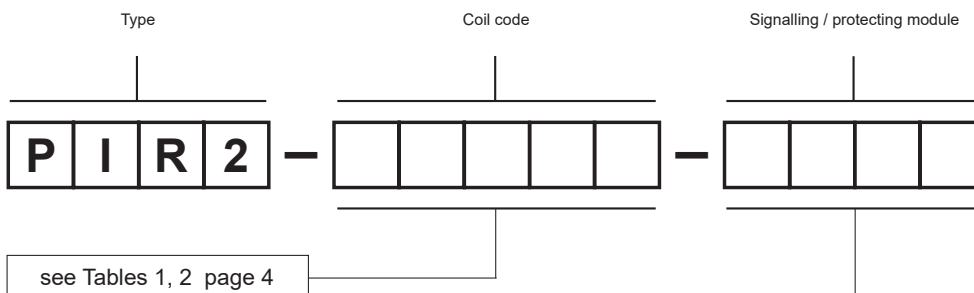

### Signalling / protecting module

- 00LD** - M41G - module LD (LED green + diode D, polarization N: +A1/-A2), 6/24 V DC
- 00LD** - M42G - module LD (LED green + diode D, polarization N: +A1/-A2), 24/60 V DC
- 00LD** - M43G - module LD (LED green + diode D, polarization N: +A1/-A2), 110/230 V DC
- 00LV** - M91G - module LV (LED green + varistor), 6/24 V AC/DC
- 00LV** - M92G - module LV (LED green + varistor), 24/60 V AC/DC
- 00LV** - M93G - module LV (LED green + varistor), 110/240 V AC/DC

Examples of ordering codes:

### PIR2-012DC-00LD

interface relay **PIR2** consists of: relay **R2N** (two changeover contacts, contact material AgNi, coil voltage 12 V DC), socket **GZM2** (grey, screw terminals), signalling / protecting module **M41G** (version LD), retainer / retractor clip **GZT4-0040** (plastic), description plate **GZT4-0035** (white)

### PIR2-230AC-00LV

interface relay **PIR2** consists of: relay **R2N** (two changeover contacts, contact material AgNi, coil voltage 230 V AC 50/60 Hz), socket **GZM2** (grey, screw terminals), signalling / protecting module **M93G** (version LV), retainer / retractor clip **GZT4-0040** (plastic), description plate **GZT4-0035** (white)

### PRECAUTIONS:

1. Ensure that the parameters of the product described in its specification provide a safety margin for the appropriate operation of the device or system and never use the product in circumstances which exceed the parameters of the product.
2. Never touch any live parts of the device.
3. Ensure that the product has been connected correctly. An incorrect connection may cause malfunction, excessive heating or risk of fire.
4. In case of any risk of any serious material loss or death or injuries of humans or animals, the devices or systems shall be designed so to equip them with double safety system to guarantee their reliable operation.

## Interconnection strips ZGGZ4



PIR2-...-00L.  
(R2N + GZM2)

ZGGZ4

### ■ ZGGZ4 for:

| Plug-in sockets | Relays for plug-in sockets | Interface relays ⓘ         |
|-----------------|----------------------------|----------------------------|
| GZM2            | R2N                        | PIR2-...-00L. (R2N + GZM2) |
| GZT2            |                            |                            |
| GZM3            | R3N                        | PIR3-...-00L. (R3N + GZM3) |
| GZT3            |                            |                            |
| GZM4            | R4N                        | PIR4-...-00L. (R4N + GZM4) |
| GZT4            |                            |                            |

ⓘ Interface relay **PIR2 (PIR3, PIR4)** is offered as a **set**: electromagnetic relay **R2N (R3N, R4N)** + plug-in socket **GZM2 (GZM3, GZM4)** + signalling / protecting module type **M...** + retainer / retractor clip **GZT4-0040** + description plate **GZT4-0035**.

### ■ Interconnection strip ZGGZ4

- designed for the co-operation with plug-in sockets of miniature industrial relays and with interface relays PIR2, PIR3 and PIR4, which are equipped with screw terminals; sockets and relays are mounted on 35 mm rail mount acc. to EN 60715,
- bridges common input signals (coil terminals A1 or A2) or output signals - see photo at the top,
- maximum permissible current is 10 A / 250 V AC,
- possibility of connection of 6 sockets or relays,
- colours of strips: **ZGGZ4-1** grey, **ZGGZ4-2** black.

