

RPB-2PSM-UNI

bistable - impulse relays



RPB-2PSM-UNI



- **Bistable - impulse relays type "ON-OFF", multifunction - sequential with memory**
- Cadmium - free contacts 2 x 1 CO • AC/DC input voltages
- Cover - modular, width 17,5 mm
- Direct mounting on 35 mm rail mount acc. to EN 60715
- Applications: in cooperation with control switches ❶; electric systems; switchgears of modular equipment
- Compliance with standard EN 61810
- Recognitions, certifications, directives: RoHS, EMC ❷ **CE ENEC**

Output circuit - contact data

Number and type of contacts	2 x 1 CO		
Contact material	AgSnO ₂		
Max. switching voltage	300 V AC / 300 V DC		
Rated load	AC1	16 A / 250 V AC	
	DC1	16 A / 24 V DC	
Max. inrush current	30 A		
Rated current	16 A		
Max. breaking capacity	AC1	2 x 4 000 VA	
Min. breaking capacity	1 W 10 V, 10 mA		
Contact resistance	≤ 100 mΩ		
Max. operating frequency	• at rated load AC1	600 cycles/hour	
	• no load	3 600 cycles/hour	
Input circuit			
Rated voltage	AC: 50/60 Hz AC/DC	12...240 V	terminals (+)A1, (-)A2
Must release voltage		AC: ≥ 0,15 U _n	DC: ≥ 0,05 U _n
Operating range of supply voltage		0,85...1,15 U _n	
Rated power consumption		≤ 1,7 W	
Control contact S ❶	• load	no	
	• min. voltage ❸	0,85 U _n	
	• min. time of pulse duration ❹	≥ 55 ms	
Insulation according to EN 60664-1			
Insulation rated voltage	250 V AC		
Rated surge voltage	4 000 V 1,2 / 50 μs		
Overvoltage category	III		
Insulation pollution degree	2		
Flammability class		V-0	for modular cover, UL 94
Dielectric strength	• input - output	4 000 V AC	type of insulation: basic
	• contact clearance	1 000 V AC	type of clearance: micro-disconnection
	• pole - pole	2 000 V AC	type of insulation: basic
General data			
Operating / release time (typical values)	60 ms / 60 ms		
Electrical life	• resistive AC1	0,5 x 10 ⁵	contact 1 NO, 16 A, 250 V AC ❺
Mechanical life (cycles)	10 ⁷		
Operation cycle	1:1		
Dimensions (L x W x H)	90 ❻ x 17,5 x 64,6 mm		
Weight	83 g		
Ambient temperature	• storage	-40...+70 °C	
(non-condensation and/or icing)	• operating	-20...+55 °C	
Cover protection category		IP 20	EN 60529
Relative humidity	up to 85%		
Shock / vibration resistance	15 g / 0,35 mm DA 10...55 Hz		
Function data			
Functions	BOTH, RESET BOTH, RESET SEQ, SEQ		
LED indicator	green LED U ON - indication of supply voltage U yellow LEDs R1, R2 ON/OFF - output relays status		

❶ Control contact S provides control of switching ON/OFF of receivers (lighting or other devices) from a few different points, with the use of connected in parallel momentary (doorbell) switches; the relays cannot operate with lit-up buttons. ❷ EMC tests (electromagnetic compatibility): EN 55011, EN 61000-4-2/3/4/5/6/11. ❸ Where the control signal is recognizable. ❹ Continuous voltage applied between A1, A2, activated with the control contact S. ❺ Length with 35 mm rail catches: 98,8 mm.

Functions

BOTH - Simultaneous switching ON and OFF with memory, controlled by pulses on the contact S.

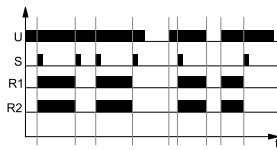

On occurrence of a pulse on the control input S, output relays R1 and R2 are switched on. This status lasts until another control pulse occurs - then, the output relays R1 and R2 are switched off.

Further control pulses which will occur on the control input S will change status of the contacts of R1 and R2 into an opposite one.

In case the U supply is interrupted and then switched on again, the R1 and R2 contacts of the output relays will return to the status prior to switching the U supply off, and the relay will start operation according to the foregoing function.

SEQ - Sequential switching ON and OFF with memory, controlled by pulses on the contact S.

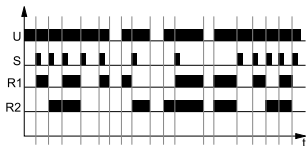

When a pulse occurs on the control input S, the output relay R1 is switched on. The status lasts until another control pulse occurs - then, the output relay R1 is switched off, and the R2 relay is switched on.

Another control pulse will activate the R1 contact - both R1 and R2 relays are on. Another control pulse S will switch both R1 and R2 relays off.

Consecutive pulses occurring on the control input S will cause a change of the status of the R1 and R2 contacts according to the foregoing sequence, i.e.:

- R1 off, R2 off (supply activated, R1, R2 were previously off),
- R1 on, R2 off (first control pulse),
- R1 off, R2 on (second control pulse),
- R1 on, R2 on (third control pulse),
- R1 off, R2 off (fourth control pulse), etc.

In case the U supply is interrupted, the R1, R2 relays are switched off. Switching the supply voltage on again will recover the status of switching on / off of the R1, R2 relays prior to switching the U supply off.

Further pulses to occur on the control input S will cause a change of the status of the R1, R2 contacts according to the foregoing sequence, from the status prior to switching the supply off.

RESET BOTH - Simultaneous switching ON and OFF, controlled by pulses on the contact S.

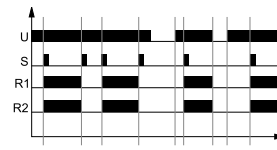

On occurrence of a pulse on the control input S, output relays R1 and R2 are switched on. This status lasts until another control pulse occurs - then, the output relays R1 and R2 are switched off.

Further control pulses which will occur on the control input S will change status of the contacts of R1 and R2 into an opposite one.

In case the U supply is interrupted and then switched on again, the R1 and R2 contacts of the output relays will start operation from switching off (R1 off, R2 off). Then, when the pulse occurs again on the control input S, the relay will start operation according to the foregoing function.

RESET SEQ - Sequential switching ON and OFF, controlled by pulses on the contact S.

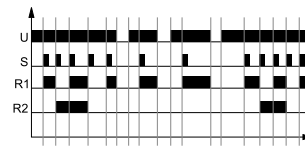

When a pulse occurs on the control input S, the output relay R1 is switched on. The status lasts until another control pulse occurs - then, the output relay R1 is switched off, and the R2 relay is switched on.

Another control pulse will activate the R1 contact - both R1 and R2 relays are on. Another control pulse S will switch both R1 and R2 relays off.

Consecutive pulses occurring on the control input S will cause a change of the status of the R1 and R2 contacts according to the foregoing sequence, i.e.:

- R1 off, R2 off (supply activated, R1, R2 were previously off),
- R1 on, R2 off (first control pulse),
- R1 off, R2 on (second control pulse),
- R1 on, R2 on (third control pulse),
- R1 off, R2 off (fourth control pulse), etc.

In case the U supply is interrupted, the R1, R2 relays are switched off. Following switching the supply voltage on again, the R1, R2 remain off.

Further pulses to occur on the control input S will cause a change in the status of the R1, R2 contacts according to the foregoing sequence.

U - supply voltage; R1, R2 - output states of the relays; t - time axis

Additional functions

LEDs: green U, yellows R1, R2 - are lit permanently.

Adjustment of the set values: the function may be changed after the supply voltage has been switched off and on again. If the memory function was set, and a no-memory function is set next, the memory is cancelled in such case.

Triggering: the relay is triggered by connecting the contact S to the A1 terminal, from connected in parallel control switches. For DC supply, the positive pole must be connected to A1 terminal.

Supply: the relay may be supplied with DC voltage or AC voltage 50/60 Hz of 10,2...276 V.

RPB-2PSM-UNI

bistable - impulse relays

Dimensions

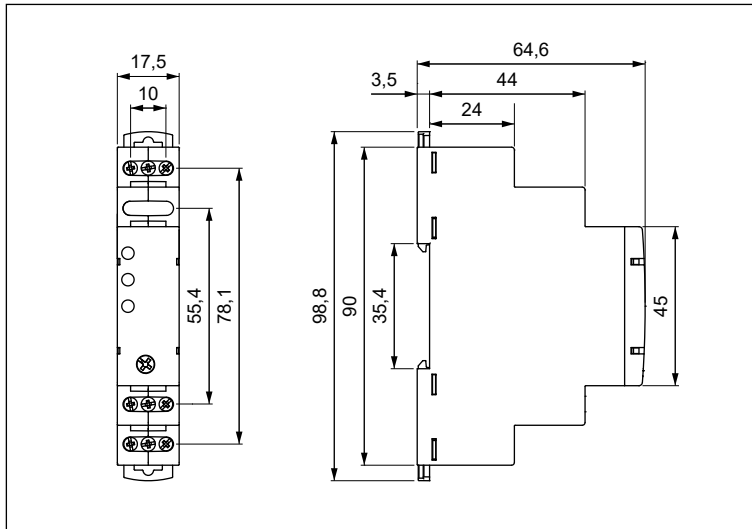

Front panel description

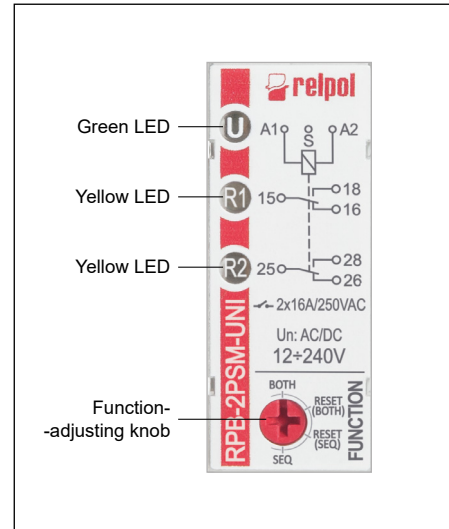

Connection diagrams

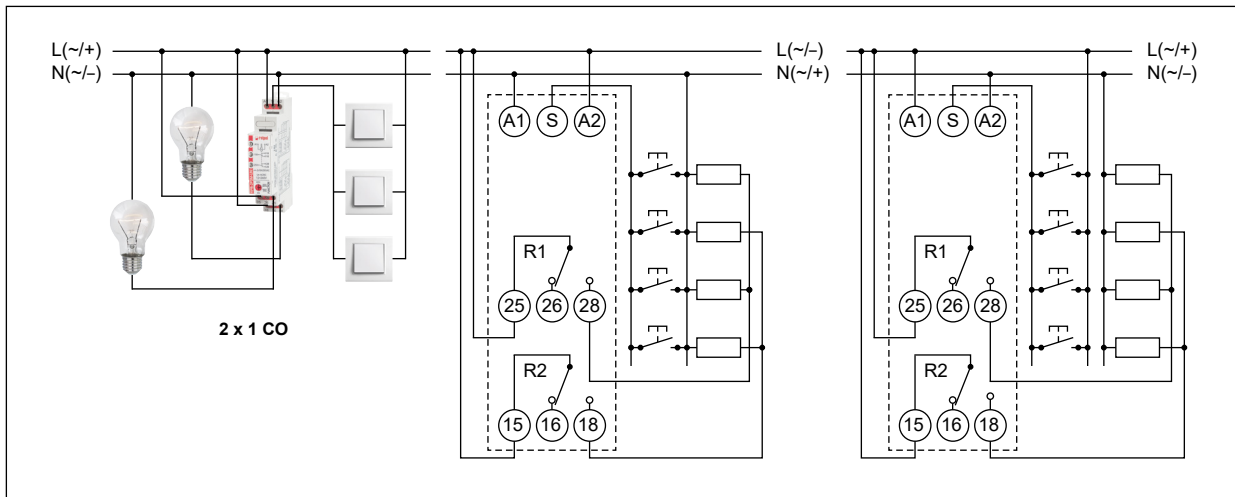

Mounting

Relays **RPB-2PSM-UNI** are designed for direct mounting on 35 mm rail mount acc. to EN 60715. Operational position - any. **Connections:** max. cross section of the cables: 1 x 2,5 mm² (1 x 14 AWG), stripping length: 6,5 mm, max. tightening moment for the terminal: 0,5 Nm.

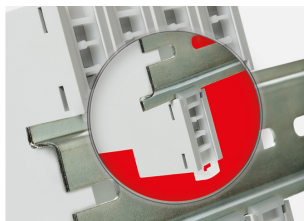

Two catches:
easy mounting
on 35 mm rail,
firm hold
(top and bottom).

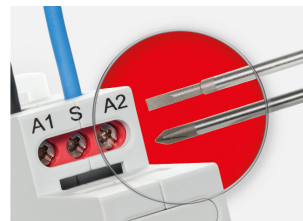

**Mounting wires
in clamps:**
universal screw
(cross-recessed
or slotted head).

RPB-2PSM-UNI

bistable - impulse relays

Ordering codes

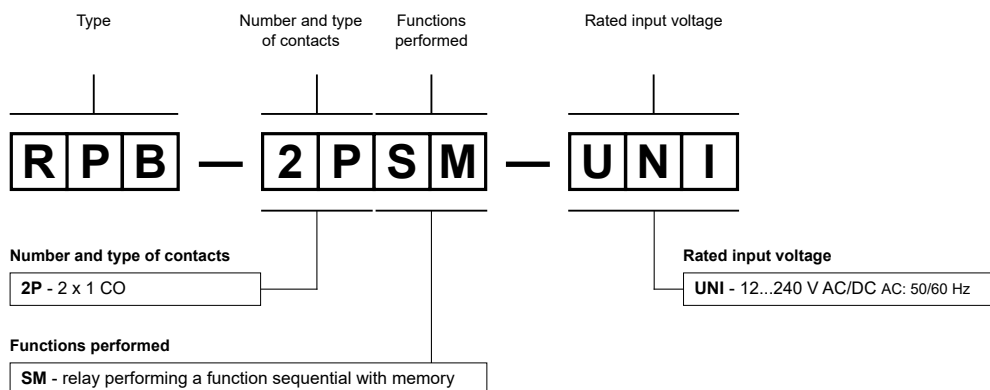

Example of ordering codes:

RPB-2PSM-UNI

bistable - impulse relay **RPB-2PSM-UNI**, multifunction (relay perform 4 functions), cover - modular, width 17,5 mm, two changeover contacts, contact material AgSnO₂, rated input voltage 12...240 V AC/DC AC: 50/60 Hz



PRECAUTIONS:

1. Ensure that the parameters of the product described in its specification provide a safety margin for the appropriate operation of the device or system and never use the product in circumstances which exceed the parameters of the product. 2. Never touch any live parts of the device. 3. Ensure that the product has been connected correctly. An incorrect connection may cause malfunction, excessive heating or risk of fire. 4. In case of any risk of any serious material loss or death or injuries of humans or animals, the devices or systems shall be designed so to equip them with double safety system to guarantee their reliable operation.